

RADIAL FAN WITH FORWARD CURVED BLADES

Радиальный вентилятор с вперед загнутыми лопатками

Radialventilator mit vorwärts gekrümmten Schaufeln

Wentylator promieniowy z łopatkami pochyłonymi do przodu



Motor type:

Voltage / Напряжение / Spannung / Napięcie znamionowe:

Maximum pressure / Полное давление / Maximaler Druck / Spręż max.:

Max. air flow / Макс. производ. / Max Luftfördermenge / Wydatek max.:

Speed / Частота вращения / Drehzahl / Prędkość obrotowa:

Power input / Входная мощность / Leistungsaufnahme / Moc pobierana:

Weight / Масса / Gewicht / Masa:

Material of impeller / Материал ротора

/ Laufradmateriал / Materiał wirnika:

Flange / Фланец / Flansche / Kołnierz:

Size and holes can be adapted to the requirements

/ Размер и отверстия могут быть адаптированы к требованиям

/ Größe und Bohrungen kann den Anforderungen angepasst werden

/ Rozmiar i otwory mogą być dostosowane do wymagań

Fan dimensions / Размеры вентилятора

/ Lüfterabmessungen / Wymiary wentylatora:

Connection diagram / Схема подключения

/ Anschlussbild / Schemat połączenia:

Curves / Характеристика / Curves / Charakterystyka:



R2E 140-AI28-05

230V/50Hz

390 Pa

505 m³/h

2400 rpm

160 W

3,50 kg

galvanized steel / оцинкованная сталь

/ verzinkter Stahl / stal cynkowa

WPA HL 145

*possible variant of a motor
(R2E 140-AI28-YF)
with Hall sensor*

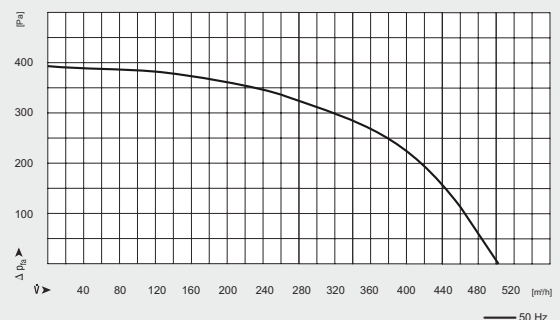
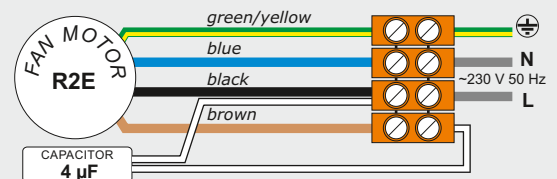
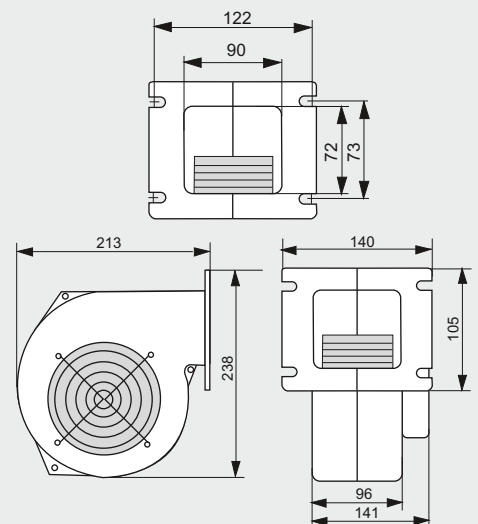

Screen / Диафрагма / Blende / Przystłona:

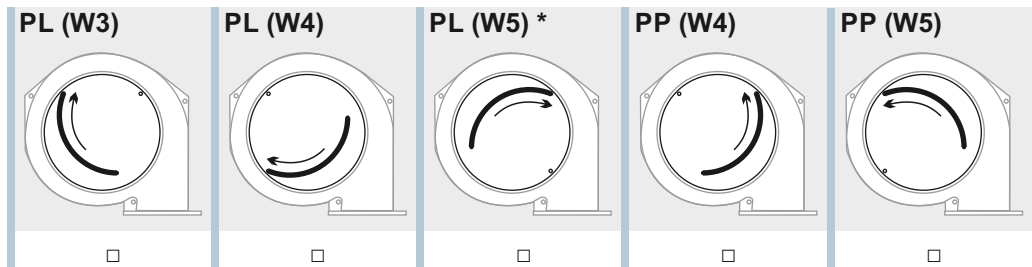

* PL(W5) - collision with normal valve KZW and deep valve KGŁ

Valve / Заслонка / Klappe / Klapka:

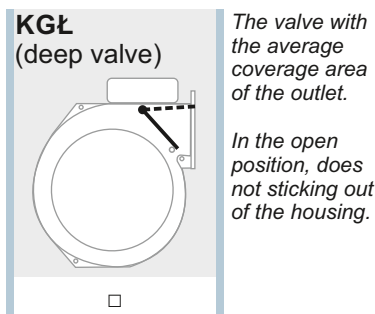
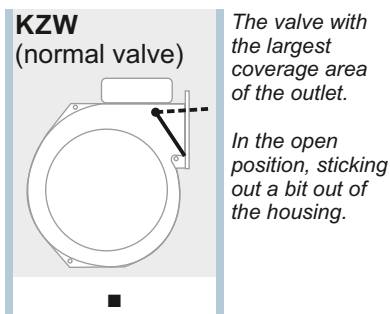

Terminal box / Клеммная коробка / Schaltschrank / Puszka elektryczna:

Upper assembly, with hole for the power cord

Side assembly, with IEC socket

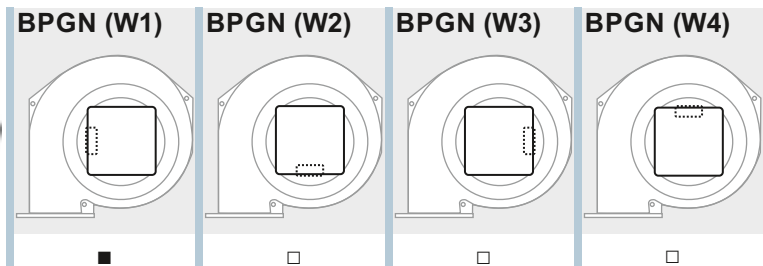
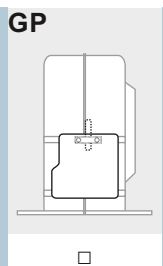

Upper assembly, with IEC socket

Side assembly, with hole for the power cord

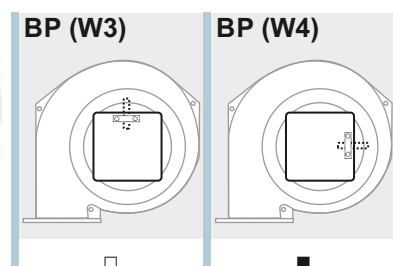
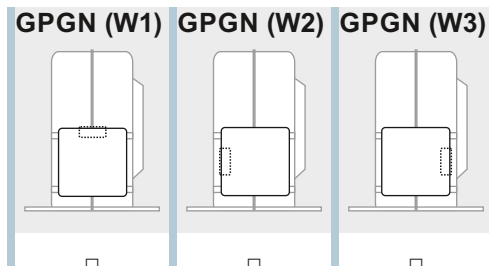

Power cable / Кабель питания / Stromkabel / Kabel sieciowy:



- +0,15m
 - +0,30m
 - +0,80m
 - +1,60m
 - +2,00m
 - +2,50m
 - +3,00m
-

Gasket / Уплотнение / Dichtung / Uszczelka:



U

flange gasket made of cork-rubber blend

■

Housing painted / Корпус окрашен / Cover lackiert / Malowana obudowa:



M

black semi-gloss powder coating

■